

Zumtobel Research

Measurement of lighting of Pablo Picasso's
"Harlekin" (1916) at the Lindau Town Museum

Abstract		5
-----------------	--	---

Short Summary		6
----------------------	--	---

1 Problem definition		9
2 State of science		
3 Research hypotheses		
4 Theoretical background		10

5 Research methods	5.1 Selection of methods	12
	5.2 Test setup	12
	5.3 Test implementation	14

6 Results	6.1 Object-independent luminaire data	16
	6.2 Luminaire data on the object	19
	6.3 Calculation for the lighting situations in the museum	22
	6.4 Evaluation of results	24

7 Best practice	7.1 Städel Museum in Frankfurt	26
	7.2 Kunsthistorisches Museum in Vienna	27
	7.3 Ethnological Museum in Berlin	27

8 Discussion and outlook		28
---------------------------------	--	----

9 Literature		29
---------------------	--	----

10 Brief portrait of the partners		30
--	--	----



Harlequin, Pablo Picasso, 1916, pencil on paper, 30 cm x 21.5 cm, private collection

Various lighting parameters that are especially relevant for art are to be evaluated based on a drawing from Pablo Picasso from 1916 that shows a harlequin as its subject. The evaluation parameters consist of electrical and photometric characteristics of the luminaires as well as illuminance, homogeneity, effective illuminance E_{dm} and damage potential P_{dm} according to CIE 157:2004. Specifically, two spotlights with either a tungsten halogen lamp or LED as light sources are compared within several settings. The on-site measurements were implemented on 30 August 2011 as part of the Picasso exhibition at the Lindau Town Museum.

Short Summary

Masterpieces of art are often found in museums and galleries. Creating perfect centre-stage settings for precious exhibits involves not only fulfilling architectural and artistic aspirations; conservation requirements must also be taken into account, because light that is not used properly may damage exhibits. This makes it even more important to use an appropriate lighting solution that provides adequate illumination and sets the scene for objects gently but highly effectively. The latest test report recently produced for Zumtobel by the Lighting Engineering Department of Darmstadt's University of Technology offers a new basis for argumentation. As part of the study, the quality of various light sources was tested on a real object of art using predefined evaluation parameters. The principal result: using state-of-the-art LED technology reduces UV and IR radiation thanks to its special properties; moreover, the colour temperature is kept constant during dimming, and energy efficiency is increased while reducing the risk of damage to works of art.

The test object selected was Picasso's "Harlequin" drawing dating back to 1916, which was exhibited as part of the Picasso exhibition "Meisterzeichnungen eines Jahrhundertgenies" (master drawings by a once-in-a-century genius) in summer 2011 at the Lindau Town Museum and could be used on-site for the study.

Two different light sources pointed at the drawing were installed one after the other for this examination. Two spotlights were compared – one using conventional lamp technology (tungsten halogen lamps), and the other using LED. Assessment parameters that are especially important for works of art were defined in order to test the various features of the light sources. These include both the electrical as well as the photometric characteristics of the luminaires, such as:

- light colour
- spectral radiation distribution
- colour rendering
- illuminance
- homogeneity
- potential for damage
- installed electrical load

The Zumtobel XENO spotlight that can be dimmed via a potentiometer was used for the conventional lighting technology. The ARCOS spotlight with Tunable White function was used for the LED luminaire. The LED luminaire allows to adjust light colour and brightness from 2,700 to 6,500 K via a DALI control system. In order to compare the factors of influence of the light sources, Zumtobel examined the evaluation parameters with various initial situations: the halogen spotlight was measured in dimmed and undimmed state. With the LED spotlight, various colour temperature settings were taken from warm to cold white.

The damage potential is viewed as one of the most important evaluation parameters, and this concerns the level of object damage as specified by the spectral radiation distribution of the light source and the spectral sensitivity of the art object. Besides IR radiation that causes heat on the object and thus can also lead to drying out and the formation of cracks, as well as light that is visible to the human eye, UV radiation plays a decisive role when it comes to damage. The shorter the radiation wavelength the more damaging this is for art objects. Observers can often see this damage with colour changes such as the fading of a picture under the influence of daylight, which usually has a high UV component. According to carrier base material of an art object, material parameters have been defined according to the CIE standard 157:2004 that are the basis for spectral sensitivity.

The material used in the Harlequin is a thin, lightly wavy paper that has been attached to a heavy carrier paper, and that in terms of final composition is most similar to rag paper. For this reason the characteristics of this type of paper were used for evaluation of damage.

The LED lighting was set to a similar lighting level as the halogen lighting. The result demonstrates that the lighting with the halogen spotlight shows visible irregularities compared to the LED lighting. While colour temperature changes when the halogen spotlight is dimmed from 2,000 K to 2,900 K, colour temperature of the LED spotlight is independent of the light colour. Colour rendering with R_a 99 is excellent with the halogen spotlight. But the LED spotlight in warm colour temperatures has an R_a of 91 to 93 (very good); only with cool colour temperatures (6,500 K) is the value reduced to R_a 84.

Results of the photometric measurement with Picasso's "Harlequin" with a comparison of halogen and LED lighting

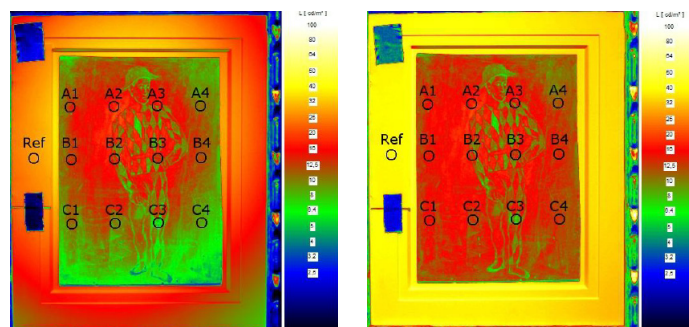

Luminance recording: illumination by XENO M 1/100 W QR111 halogen spotlight, dimmed, 118 mA

Luminance recording: illumination by ARCOS 3 LED Tunable White, 2,700 K, 19 % dimmed

The LED lighting measured in this case shows a lower damage potential than the halogen spotlight with similar colour temperature. Even with a neutral colour temperature, the damage potential is comparable to the halogen lighting. A lower damage potential means in this case that a lower effective intensity of radiation exists and the critical radiation time can be increased with identical illuminance. In addition, the required energy consumption is significantly less with LED lighting. LED lighting exceeds the damage potential of dimmed halogen lighting only at higher colour temperatures.

Comparison of the damage potential and threshold radiation time of the tested lighting situations

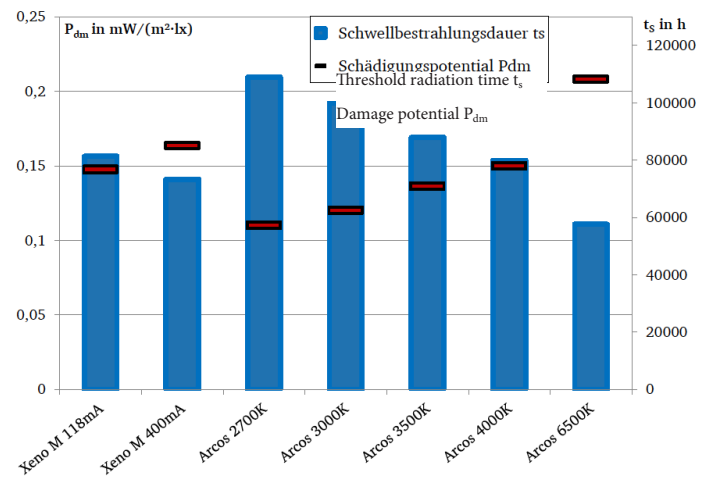

It is therefore worthwhile to use LEDs in museum applications, taking into account that the spectral distribution of the light source must be as harmless as possible.

1 Problem definition

2 State of science

3 Research hypotheses

Problem definition

With the onset of LED technology into the lighting of art objects in museum applications as well, the question of damage relating to their spectral distribution has now become apparent. This case study demonstrates how various lighting parameters and quality factors are manifested with a Picasso exhibition that was hosted by the Lindau Town Museum. The dimmed halogen lighting used was compared to LED lighting at various colour temperatures.

State of science

Today, halogen lighting is usually used in museums, as this form of lighting achieves outstanding colour rendering values and is also characterised by a low damage potential for art objects. As LED as an alternative light source was introduced into such applications, uncertainty became widespread. Narrow LED spectra had poor colour rendering, and cool white LEDs have a high damage potential.

Research hypotheses

This case study is intended to demonstrate that a modern LED lighting system in a museum application can have advantages in terms of quality of light and energy efficiency compared to halogen lighting, and that LED is definitely suited for this application. The damage potential is at least comparable with halogen lighting according to the spectrum of the implemented LED light source.

- The LED lighting is more efficient than halogen lighting
- The damage potential of LED lighting is lower than that of halogen lighting
- The damage potential significantly changes with selection of the spectrum and the colour temperature
- The use of cool white LED lighting is not suitable for the illumination of sensitive objects

4 Theoretical background

4.1 Colour Rendering Index

The colour rendering index R_a is calculated according to DIN 6169-2. The indices R_i are displayed for the colours R1 to R14.

4.2 Homogeneity

The uniformity of the illumination can be an indicator for the quality of the presentation of a piece of art. It is expressed with the values U_0 and U_1 .

$$U_0 = \frac{x_{\min}}{\bar{x}}$$

$$U_1 = \frac{x_{\min}}{x_{\max}}$$

The closer the values run to 1, the more uniform is an array of measurands. The homogeneity is calculated for the correlated colour temperature and the illuminance.

4.3 Damage potential and derived parameters

In the first place the most important dimensions for the estimation of the damage potential in the optical spectrum are introduced. The Technical Report CIE 157:2004 defines the effective irradiance E_{dm} , causing the damage of the objects according to the formula

$$E_{dm} = \int_{\lambda} E_{e,\lambda}(\lambda) \cdot s_{dm,rel}(\lambda) \cdot d\lambda$$

where $E_{e,\lambda}$ is the spectral irradiance, $s_{dm,rel}$ the relative spectral responsivity and λ the wavelength of the incident light. The relative spectral responsivity $s_{dm,rel}(\lambda)$ is

$$s_{dm,rel}(\lambda) = e^{-b(\lambda-300)}$$

with the matter constant b .

The damage potential is the ratio of effective irradiance E_{dm} and the irradiance E and is valid for a lighting situation and an object or material:

$$P_{dm} = \frac{E_{dm}}{E}$$

Using those parameters, the critical duration of exposure t_s can be defined, after which the risk of visible damage is given:

$$t_s = \frac{H_{S,dm}}{P_{dm} \cdot E}$$

with the threshold effective radiant exposure $H_{S,dm}$.

The following Table 2 shows the material dependent parameters for different fabrics. The spectral sensitivities are displayed below.

Material	Threshold effective radiant exposure $H_{S,dm} \left[\frac{\text{Wh}}{\text{m}^2} \right]$	Matter constant b
Low-grade paper	5	0,0380
Rag paper	1.200	0,0125
Oil on canvas	850	0,0115
Textiles	290	0,0100
Water colours on rag paper	175	0,0115

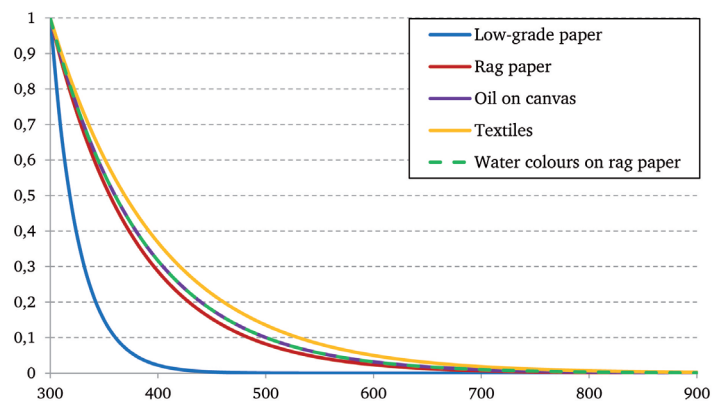

Relative spectral object sensitivities for different materials from CIE 157:2004

5 Research methods

5.1 Selection of methods

For examination of the electrical and photometric parameters, two luminaires were compared to each other: halogen lighting and LED lighting with variable colour temperatures. The measurands were initially recorded in the museum directly on the picture. The measured values were then verified in the laboratory, and the sensitive spectral range was specifically expanded for measurement of the spectral radiance.

5.2 Test setup

Measurement objects:



XENO M 1/100 W QR111 halogen spotlight (Order no. 60 711 692), the luminaire can be dimmed via a potentiometer



ARCOS 3 LED Tunable White (Order no. 60 711 570), light colour and brightness level can be adjusted via DALI control system

The halogen spotlight was measured at both full (400 mA, 231 V) and dimmed (118 mA, 231 V) power input, the LED spotlight at dimming values of 100 % and 19 % with colour temperatures set at 2,700 K, 3,000 K, 3,500 K, 4,000 K and 6,500 K. The measurands and parameters evaluated are:

Measurands, evaluated parameters

Measurements on-site:	Electrical power input
	Illuminance in measurement patterns
	Colour temperature (CCT) in measurement patterns
	Colour locus in measurement patterns
	Luminance recording of the picture
	Spectral radiance 380 to 780 nm
Laboratory measurements:	Spectral radiance 250 to 900 nm
Berechnungen:	Homogeneity of illuminance
	Homogeneity of colour locus and colour temperature
	Colour rendering index CRI (Ra and Ri)
	Damage potential
	Effective illuminance
	Critical illumination time

Photometric measurements

The spectral radiance on-site was measured with a Konica Minolta CS1000, calibrated in May 2009. The illuminance and colour measuring device HCT-99 (serial no. 4936M) was tested on 5 March 2010. The measuring camera LMK 98-3 DXP 2031 was most recently calibrated on 01.09.2009. The SP320-166 used in the laboratory was tested on 05 May 2011. All standards used for calibration are derived from national standards.

Electrical measurements

Düwi 07975 on-site, LMG500 in the laboratory, calibrated in February 2011.

5.3 Test implementation

Measurements in the museum

Due to the conservation-related air-conditioning in the museum, the measurements could not be carried out in the specified temperature range of 25 ± 2 °C, as the temperature in the museum was 18 °C. Lighting came from a track mounted to the ceiling. The drawing shows the geometry of the room. Using a semi-transparent foil, a previously created measurement pattern was transferred to the original drawing hanging on the wall.

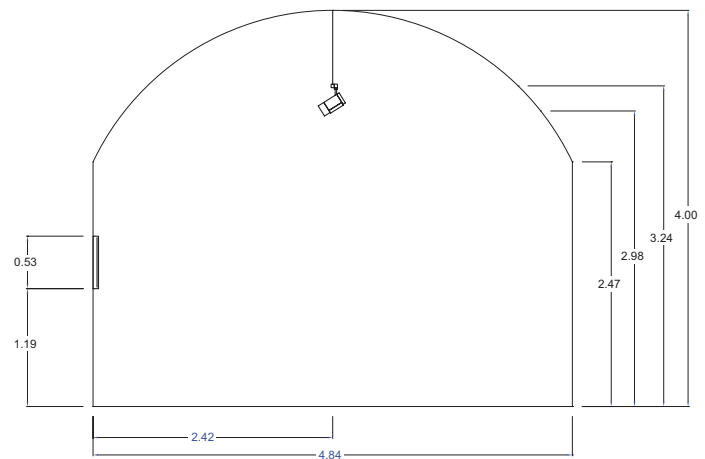

Room dimensions

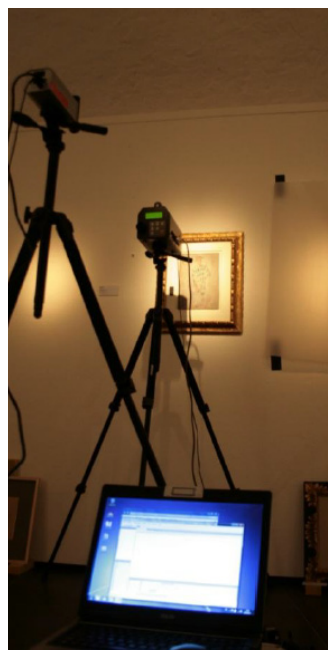

Measurement arrangement in the Lindau Town Museum

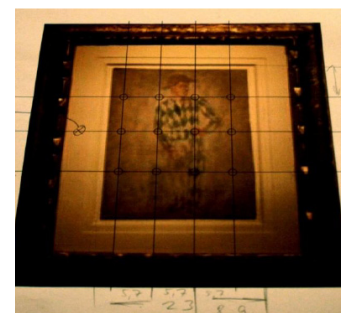

The measurement pattern was defined so that the measurement points included the knee, the hand, the shoulder, the elbow of the harlequin and a selection of background points. The colours existing in the art work are thus represented in the most optimal way. A reference white is positioned to the left.

Measurement arrangement in the laboratory

The measurements in the laboratory were carried out on an optical table. The luminaires were burnt in at least 30 minutes before the measurements. The spectral radiation intensity levels were measured at distances of two metres at the centre of light distribution of each luminaire. For each luminaire, the measurements were taken at full brightness and at the same operating brightness as in the museum.



Measurement arrangement in the laboratory

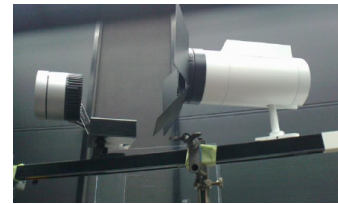

6 Results

6.1 Object-independent luminaire data

The following tables show the calculations from the spectral radiance measurement in the laboratory as well as the wattage measurement. The spectral radiation distributions are shown in the graph. The next section specifies the colour rendering indices Ri of the individual luminaires and settings.

The XENO halogen spotlight was measured in dimmed and un-dimmed state. The ARCOS LED spotlight was also measured with the 100 % (non-dimmed) setting, and a dimming value was also selected, 19 % in this case, that corresponded to the dimmed state of the halogen spotlight with which the illuminance level at the object was compared. In addition, various values of correlated colour temperature were set via the DALI control system.

Table I: Object-independent luminaire data

	XENO dimmed	XENO non-dimmed	ARCOS 2,700 K	ARCOS 2,700 K	ARCOS 3,000 K	ARCOS 3,000 K
Dimming	30 %	100 %	19 %	100 %	19 %	100 %
Wattage [W]	27.0	92.4	14.1	27.9	14.1	27.1
CCT [K]	2,032	2,717	2,519	2,546	2,786	2,790
x	0.52361	0.45898	0.47443	0.47047	0.45138	0.44969
y	0.41434	0.41118	0.41200	0.40892	0.40598	0.40330
R_a	99	99	91	92	93	93

	ARCOS 3,500 K	ARCOS 3,500 K	ARCOS 4,000 K	ARCOS 4,000 K	ARCOS 6,500 K	ARCOS 6,500 K
Dimming/current	19 %	100 %	19 %	100 %	19 %	100 %
Wattage [W]	13.6	26.3	13.5	25.8	13.8	26.6
CCT [K]	3,258	3,252	3,722	3,690	5,909	5,863
x	0.41862	0.41775	0.39371	0.39432	0.32366	0.32467
y	0.39494	0.39214	0.38496	0.38287	0.33609	0.33534
R_a	93	94	91	92	84	85

Standardised spectra

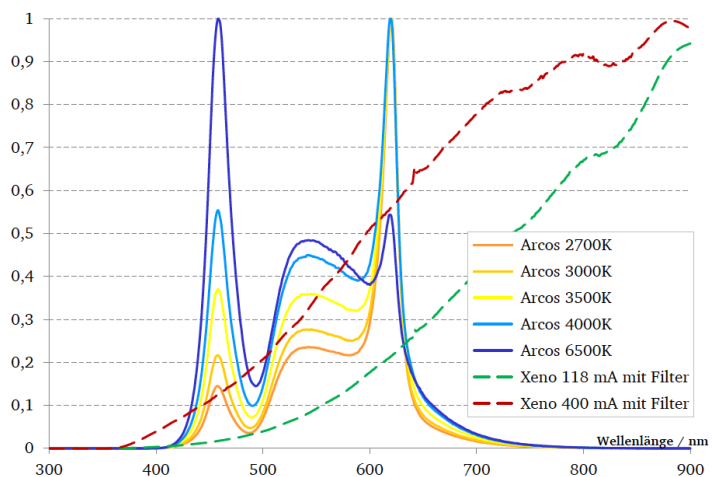

Standardised spectral distributions

R_a and R_i values

Table II: Colour rendering values of luminaires

	XENO 118 mA dimmed	XENO 400 mA non-dimmed	ARCOS 2,700 K	ARCOS 3,000 K	ARCOS 3,500 K	ARCOS 4,000 K	ARCOS 6,500 K
R_a	99	99	91	93	93	91	84
R_1	99	98	92	95	99	96	86
R_2	99	99	99	99	97	94	92
R_3	100	100	90	90	90	89	90
R_4	98	98	91	94	97	93	80
R_5	98	98	96	99	95	90	82
R_6	99	99	90	93	94	91	84
R_7	99	99	92	92	93	92	89
R_8	97	97	79	79	80	78	73
R_9	95	94	46	46	47	41	24
R_{10}	98	98	92	89	84	79	73
R_{11}	98	98	86	91	94	90	76
R_{12}	98	98	84	77	67	59	50
R_{13}	99	99	93	96	99	95	88
R_{14}	100	100	90	91	91	92	94

Colour loci in the standardised colour table

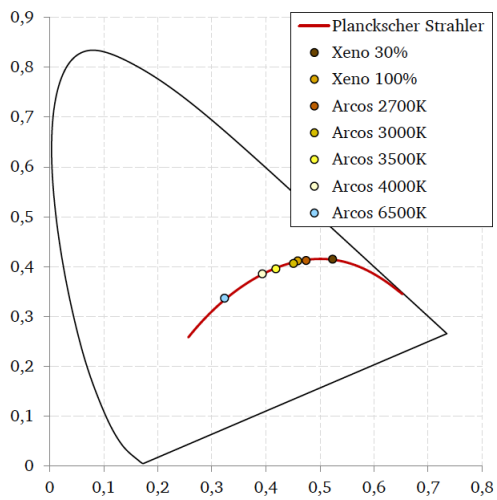

Colour loci of light sources in the standardised colour table

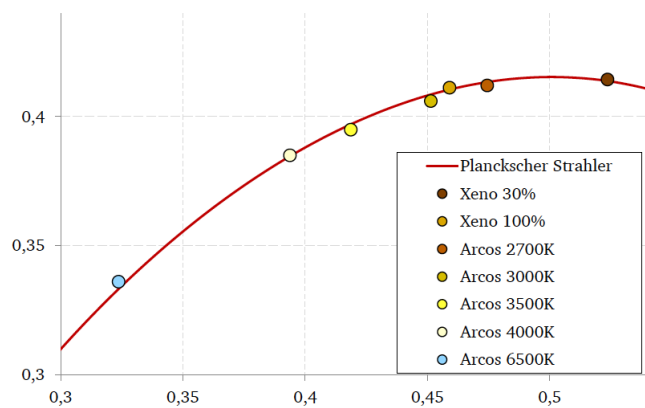

Detail view

Measurement of the IR/UV filter

The XENO M halogen luminaire has an IR/UV blocking filter attached to keep the spectral components most damaging for the art work as low as possible. This filter was spectrally measured in the laboratory.

The first figure below shows the spectra measured for the halogen spotlight with and without filter, each in dimmed and non-dimmed state. The local maximum to be seen at approximately 640 nm is a known calibration error and should be disregarded. Measurements were taken in the range of 250 nm to 1,500 nm in order to more optimally estimate the filter characteristics.

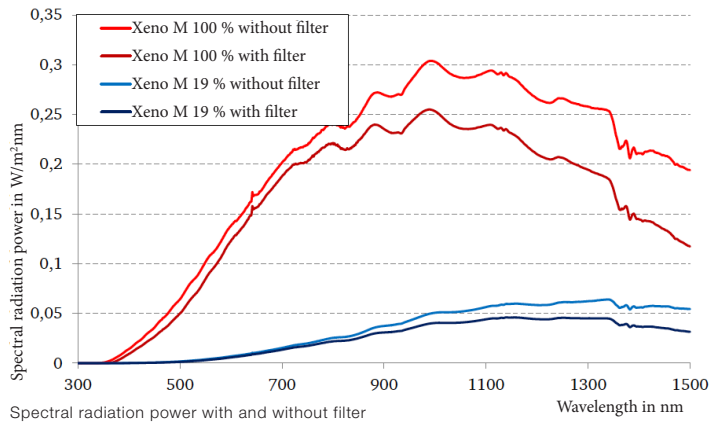

Spectral radiation power with and without filter

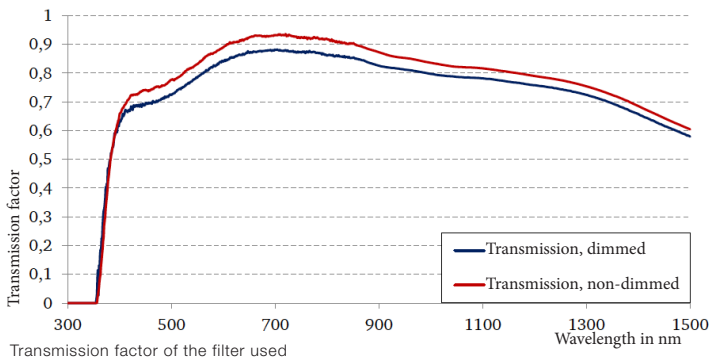

Transmission factor of the filter used

The second figure below shows the calculated transmission factor in dimmed and non-dimmed state. The difference between both states is due to a possible temperature dependence of the filter characteristics. A separate series of tests would be necessary to clarify that, though.

The filter allows no light to pass through below the wavelength of 356 nm. The values seen in the figure come from the detector noise, as seen in upper graph. At around 700 nm, the transmission factor with just over 93 % has reached its maximum, and then drops into the infrared range to 62 %. As seen in the lower graph, the filter effect below 350 nm in particular has a major influence on the damage potential, as object sensitivity is very high here. In the longer wavelength range, with rag papers above 700 nm, radiation no longer influences the damage of the material.

6.2 Luminaire data at the object

The luminance recordings and measured values specified below were taken on-site in the Lindau Town Museum. The measured data were not recorded directly at object level but on the protective glass installed in front of the drawing. Glass transmission could not be determined because no type specification for the glass could be ascertained and removal and measurement of the glass was not possible. It must therefore be considered that the actual damage potentials due to the UV protection effect of the glass are a few per cent less with all spectra measured, and that the critical radiation time is somewhat longer. The "Ref" reference point with known reflection factor was used for calibration of the measurements.

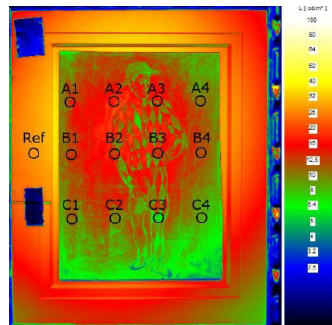

Luminance recording: illumination by XENO M 1/100 W QR111 halogen spotlight, dimmed, 118 mA

	1	2	3	4	
A	x	0.5240	0.5240	0.5243	0.5163
	y	0.4040	0.4034	0.4025	0.4095
	CCT (K)	1,900	1,966	1,940	2,038
	E (lx)	124.9	146.2	132.2	104.1
B	x	0.5240	0.5240	0.5243	0.5163
	y	0.4040	0.4034	0.4025	0.4095
	CCT (K)	1,900	1,966	1,940	2,038
	E (lx)	124.9	146.2	132.2	104.1
C	x	0.5240	0.5240	0.5243	0.5163
	y	0.4040	0.4034	0.4025	0.4095
	CCT (K)	1,900	1,966	1,940	2,038
	E (lx)	124.9	146.2	132.2	104.1

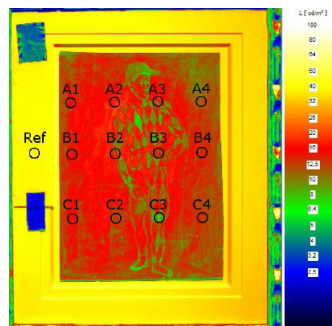

Luminance recording: illumination by ARCOS 3 LED Tunable White, 2,700 K, 19 % dimmed

	1	2	3	4	
A	x	0.5240	0.5240	0.5243	0.5163
	y	0.4040	0.4034	0.4025	0.4095
	CCT (K)	1,900	1,966	1,940	2,038
	E (lx)	124.9	146.2	132.2	104.1
B	x	0.5240	0.5240	0.5243	0.5163
	y	0.4040	0.4034	0.4025	0.4095
	CCT (K)	1,900	1,966	1,940	2,038
	E (lx)	124.9	146.2	132.2	104.1
C	x	0.5240	0.5240	0.5243	0.5163
	y	0.4040	0.4034	0.4025	0.4095
	CCT (K)	1,900	1,966	1,940	2,038
	E (lx)	124.9	146.2	132.2	104.1

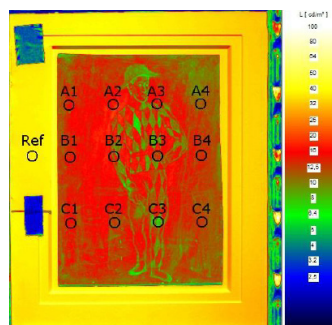

Luminance recording: illumination by ARCOS 3 LED Tunable White, 3,000 K, 19 % dimmed

	1	2	3	4	
A	x	0.5240	0.5240	0.5243	0.5163
	y	0.4040	0.4034	0.4025	0.4095
	CCT (K)	1,900	1,966	1,940	2,038
	E (lx)	124.9	146.2	132.2	104.1
B	x	0.5240	0.5240	0.5243	0.5163
	y	0.4040	0.4034	0.4025	0.4095
	CCT (K)	1,900	1,966	1,940	2,038
	E (lx)	124.9	146.2	132.2	104.1
C	x	0.5240	0.5240	0.5243	0.5163
	y	0.4040	0.4034	0.4025	0.4095
	CCT (K)	1,900	1,966	1,940	2,038
	E (lx)	124.9	146.2	132.2	104.1

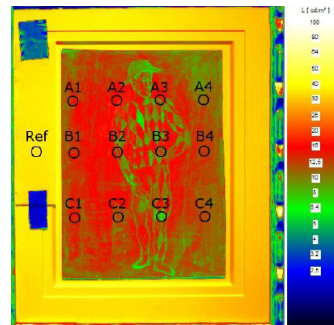

Luminance recording: illumination by ARCOS 3 LED Tunable White, 3,500 K, 19 % dimmed

	1	2	3	4	
A	x	0.5240	0.5240	0.5243	0.5163
	y	0.4040	0.4034	0.4025	0.4095
	CCT (K)	1,900	1,966	1,940	2,038
	E (lx)	124.9	146.2	132.2	104.1
B	x	0.5240	0.5240	0.5243	0.5163
	y	0.4040	0.4034	0.4025	0.4095
	CCT (K)	1,900	1,966	1,940	2,038
	E (lx)	124.9	146.2	132.2	104.1
C	x	0.5240	0.5240	0.5243	0.5163
	y	0.4040	0.4034	0.4025	0.4095
	CCT (K)	1,900	1,966	1,940	2,038
	E (lx)	124.9	146.2	132.2	104.1

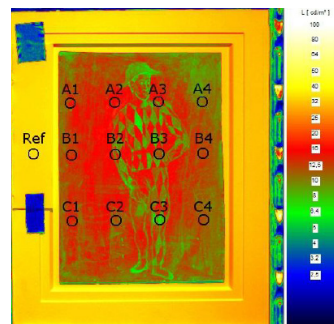

Luminance recording: illumination by ARCOS 3 LED Tunable White, 4,000 K, 19 % dimmed

	1	2	3	4	
A	x	0.5240	0.5240	0.5243	0.5163
	y	0.4040	0.4034	0.4025	0.4095
	CCT (K)	1,900	1,966	1,940	2,038
	E (lx)	124.9	146.2	132.2	104.1
B	x	0.5240	0.5240	0.5243	0.5163
	y	0.4040	0.4034	0.4025	0.4095
	CCT (K)	1,900	1,966	1,940	2,038
	E (lx)	124.9	146.2	132.2	104.1
C	x	0.5240	0.5240	0.5243	0.5163
	y	0.4040	0.4034	0.4025	0.4095
	CCT (K)	1,900	1,966	1,940	2,038
	E (lx)	124.9	146.2	132.2	104.1

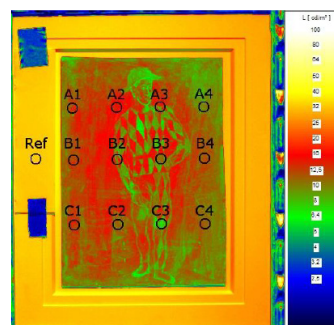

Luminance recording: illumination by ARCOS 3 LED Tunable White, 6,500 K, 19 % dimmed

	1	2	3	4	
A	x	0.5240	0.5240	0.5243	0.5163
	y	0.4040	0.4034	0.4025	0.4095
	CCT (K)	1,900	1,966	1,940	2,038
	E (lx)	124.9	146.2	132.2	104.1
B	x	0.5240	0.5240	0.5243	0.5163
	y	0.4040	0.4034	0.4025	0.4095
	CCT (K)	1,900	1,966	1,940	2,038
	E (lx)	124.9	146.2	132.2	104.1
C	x	0.5240	0.5240	0.5243	0.5163
	y	0.4040	0.4034	0.4025	0.4095
	CCT (K)	1,900	1,966	1,940	2,038
	E (lx)	124.9	146.2	132.2	104.1

6.3 Calculation for the lighting situations in the museum

The values measured in the museum were used for calculations of uniformity and mean values for illuminance and CCT. The damage potential is based on the spectral measurements in the laboratory. The values in italics for the non-dimmed halogen luminaire were only taken on the covered "Harlequin" in order to prevent exposure of the art work to high radiation load.

The material used with the Harlequin is a thin, slightly wavy paper mounted to a heavy base paper. This is represented by the rag paper.

Lighting situation in the museum

	XENO dimmed	XENO non-dimmed	ARCOS 2,700 K	ARCOS 3,000 K	ARCOS 3,500 K	ARCOS 4,000 K	ARCOS 6,500 K
Colour temperature in centre of luminaire [K]	2,032	2,717	2,519	2,786	3,258	3,722	5,909
$U_{0,CCT}$	0.971	0.991	0.992	0.986	0.976	0.990	0.984
$U_{1,CCT}$	0.952	0.986	0.982	0.973	0.965	0.980	0.969
Mean illuminance \bar{E} [lx] 112.4	2,651.2	136.4	130.3	126.7	123.1	118.4	
Minimum illuminance E_{min} [lx] 71.8	1,647.4	124.2	119.6	116.9	112.8	108.7	
Maximum illuminance E_{max} [lx] 146.2	3,427.2	136.4	138.0	133.0	130.1	123.8	
$U_{0,E}$	0.639	0.621	0.911	0.918	0.923	0.917	0.919
$U_{1,E}$	0.491	0.481	0.862	0.867	0.879	0.867	0.879
R_a	99	99	91	93	93	91	84
Damage potential $\left[\frac{mW}{m^2 \cdot lx} \right]$							
Newsprint	0.0009	0.0026	0.0008	0.0010	0.0013	0.0016	0.0026
Rag paper	0.1476	0.1637	0.1102	0.1202	0.1365	0.1501	0.208
Oil on canvas	0.2025	0.2102	0.1394	0.1510	0.1698	0.1856	0.2532
Textiles	0.3338	0.3128	0.2000	0.2142	0.2374	0.2569	0.3414
Watercolour on rag paper	0.2025	0.2102	0.1394	0.1510	0.1698	0.1856	0.2532
Effective intensity of irradiation $\left[\frac{mW}{m^2} \right]$ with mean illuminance on the art work							
Newsprint	0.105	6.911	0.112	0.131	0.165	0.192	0.311
Rag paper	16.585	434.11	15.026	15.666	17.289	18.481	24.65
Oil on canvas	22.756	557.19	19.018	19.678	21.511	22.846	29.978
Textiles	37.518	829.21	27.284	27.912	30.072	31.623	40.422
Watercolour on rag paper	22.756	557.19	19.018	19.678	21.511	22.846	29.978
Threshold radiation time [h] with mean illuminance on the art work							
Newsprint	47,799	724	44,704	37,993	30,356	26,037	16,057
Rag paper	75,353	2,764	79,863	76,599	69,406	64,932	48,670
Oil on canvas	37,353	1,526	44,694	43,196	39,514	37,205	28,354
Textiles	7,730	350	10,629	10,390	9,643	9,170	7,174
Watercolour on rag paper	7,690	314	9,202	8,893	8,135	7,660	5,838
Effective intensity of irradiation $\left[\frac{mW}{m^2} \right]$ with identical illuminance $E = 100$ lx							
Newsprint	0.093	0.261	0.082	0.101	0.130	0.156	0.263
Rag paper	14.756	16.374	11.016	12.023	13.646	15.013	20.824
Oil on canvas	20.245	21.016	13.943	15.102	16.978	18.559	25.319
Textiles	33.379	31.277	20.003	21.421	23.735	25.689	34.140
Watercolour on rag paper	20.245	21.016	13.943	15.102	16.978	18.559	25.319
Threshold radiation time [h] with identical illuminance $E = 100$ lx							
Newsprint	53,726	19,182	61,291	49,717	38,381	32,095	19,040
Rag paper	81,325	73,287	108,933	99,808	87,941	79,933	57,627
Oil on canvas	41,985	40,445	60,964	56,283	50,065	45,799	33,571
Textiles	8,688	9,272	14,498	13,538	12,218	11,289	8,494
Watercolour on rag paper	8,644	8,327	12,551	11,588	10,308	9,429	6,912

6.4 Evaluation of the results

Illuminance

As seen from the tables in 6.3, the LED luminaire was controlled to a similar lighting level as the halogen luminaire. It is noticeable that on the small surface of the “Harlequin” the halogen luminaire is not able to produce lighting that is sufficiently homogeneous for observers not to notice the irregularities. This is usually the case from an U_0 or U_1 of > 0.9 . These irregularities can significantly influence the effect of the art work on observers. The LED spotlight achieves homogeneous light distribution with high values for U_0 and U_1 . The control of illuminance with the halogen spotlight is via current dimming, and is continuously possible over a wide range. However, the light colour is strongly affected and changes from 2,000 K up to 2,900 K, while dimming the LED spotlight’s illuminance level does not affect its light colour.

Light colour

The dimmed XENO M emits white light with a very low colour temperature. This light is comparable to candlelight. To produce light colours that appear white to observers, current feed must be increased to achieve very high illuminance levels. Higher illuminance levels, however, cause an increased E_{dm} . Light colour uniformity is very high. The light colour of the LED spotlight can be controlled independently of the illuminance level, whereby the measured values for colour temperature partly deviate strongly from the set values (see table 6.1/I).

Colour rendering according to DIN 6196 / CIE 13.3-1995

The colour rendering values of the halogen spotlight are excellent with R_i and R_a values of 99, which is in the nature of things. There are various results with the various spectra of the LED luminaire. With colour temperatures up to 4,000 K, R_a exceeds 90 points and can be regarded as “very good”. At higher colour temperatures, here 6,500 K, the value sinks to 84 points and can only be designated as “good”. With LEDs, the colour rendering of deep red colours is particularly problematic, but with increasing colour temperature deep blue tones are not completely correctly rendered either. Table 6.1/II lists all colour rendering values.

Damage potential, effective illuminance and critical radiation time

The damage potential of a spectrum can be readily compared as this is a relative quantity, independent of the total energy of the spectrum. An ARCOS LED spectrum measured here with comparable colour temperature demonstrates lower damage potentials with all materials specified in CIE 157:2004 when compared to a halogen spectrum. With identical illuminance levels this leads to lower effective levels of intensity of irradiation and thus to significantly higher critical radiation times. If at the same illuminance level ($E = 100 \text{ lx}$) the spectrum of the halogen luminaire at 2,900 K (non-dimmed) is compared to that of the ARCOS spotlight at 2,780 K, for the LED spotlight it is possible with most materials to extend the illumination time by approximately 50 % with no visible damage occurring. With newsprint, the critical illumination time is extended by as much as 300 %.

But even in the various lighting situations found in museums, LED lighting that is comparable with regard to colour demonstrates lower effective intensity levels of radiation despite higher illuminance levels, and therefore a longer critical radiation time.

It is only with higher colour temperatures (approx. 3,250 K) of LED lighting that the radiation times for halogen lighting in museums become comparable at 2,150 K.

Finally it must also be considered that the protective glass in front of the art work could not be included as part of this case study. Consequently, actual damage potentials should be estimated at a few per cent less for all measured spectra and critical radiation time should be estimated somewhat longer due to the UV protection effect of the glass.

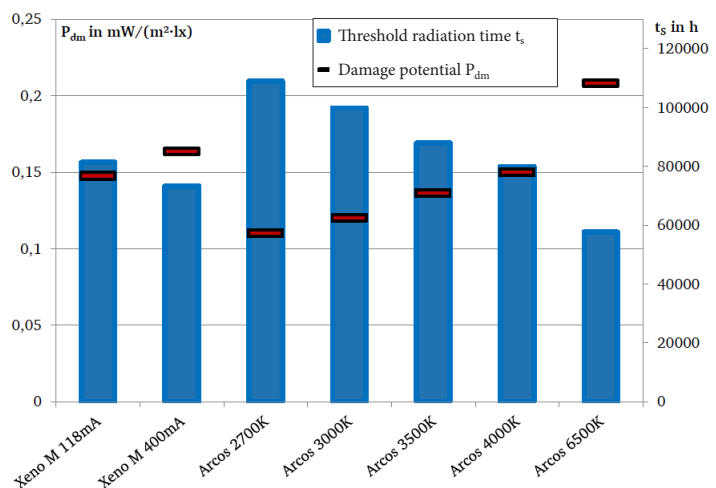

Damage potential and threshold radiation time at 100 lx

7 Best practice

7.1 Städel Museum in Frankfurt

The competition for the Städel Museum project in Frankfurt was realized with a 100 % LED lighting solution including ARCOS 3 Tunable White, projectors and a special solution for the skylights. At the start of the project the question was asked whether LED lighting might be more damaging than halogen lighting. With the help of the study, the curators as well as the decision-makers from the Städel Museum could be convinced. All of the lighting for the complete building was implemented according to the concept. The first section of the building was opened in December 2011, followed by the second section in spring of 2012.



Architects: Schneider & Schumacher | DE
Lighting design: Licht Kunst Licht | DE
Lighting solution: ARCOS 3 Tunable White, ARCOS 3 LED projectors,
LED special solution for skylights

7.2 Kunsthistorisches Museum in Vienna

During refurbishment of a building tract that will extend the exhibition area of Kunsthistorisches Museum with effect from spring 2012, utmost importance was attached to high-quality light colours and brilliance as well as to keeping potential damage by lighting as low as possible. Display cabinet lighting was implemented using SUPERSYSTEM boasting a high colour rendering index. The rooms are illuminated by a combination of SUPERSYSTEM and modern STARBRICK LED chandeliers.



Lighting design: Die Lichtplaner | DE
 Lighting solution: SUPERSYSTEM 2.5 W CRI90 (display cabinets),
 STARBRICK quadruple chandelier with additional Supersystem spots
 (rooms)

7.3 Ethnological Museum in Berlin

For the redesigned exhibition at the Ethnological Museum in Berlin, the main focus was on minimising damage through lighting. As some of the exhibits are highly sensitive, accent lighting for the display cabinets is now provided by SUPERSYSTEM featuring an elevated colour rendering index while keeping potential damage as low as possible. The exhibition was opened in spring 2011.



Lighting design: Licht Kunst Licht | DE
 Lighting solution: Supersystem 2.5 W CRI90 (display cabinets)

8 Discussion and outlook

The study demonstrates how important the consideration of various light sources is for art objects and the advantages that LED offers. From this the following summary can be made:

It is important with applications in art and culture to avoid harmful infrared and ultraviolet radiation and to keep high illuminance levels as low as possible. When these factors are taken into account, the risk of colours fading or sensitive materials being damaged is considerably reduced. For the objects on display to be presented to optimum effect, glare should be avoided as well. Moreover, a lighting system with high energy efficiency and long maintenance intervals ensures smooth operation of the museum.

In this respect, LED technology provides numerous benefits: carefully selected LEDs without filters do not emit more IR and UV radiation than other light sources fitted with filters, or even less. With their precisely focussed lighting and high colour rendering index of $R_a > 90$, they are perfectly suitable for accent lighting. In addition, maintenance costs can be considerably reduced thanks to the light sources' extremely long service life. Due to their outstanding energy efficiency, LEDs are gentle not only on the exhibits, but also on the environment and the user's budget.

Tunable White LED technology provides the particular advantage of being able to use a variety of colour temperatures – ranging from warm to intermediate and cool white – without any need for relamping or luminaire replacement. Thus, the colour temperature can be perfectly adjusted to the exhibit's material, in order to produce subtle shades and enhance particular qualities in an emotional way. The colour temperature remains consistent even when the luminaire is dimmed, enhancing visitors' appreciation of the exhibits.

Test report PB320/2011:

“Measurement of lighting of Pablo Picasso’s “Harlequin” (1916) at the Lindau Town Museum”, 2011, S. Söllner, N. Müller

CIE 157/2004 – Technical Report:

“Control of damage to Museum objects by optical radiation”



ZUMTOBEL

Germany

Zumtobel Licht GmbH
Grevenmarschstraße 74–78
32657 Lemgo
T +49/(0)5261 212-0
F +49/(0)5261 212-9000
info@zumtobel.de
www.zumtobel.de

Austria

Zumtobel Licht GmbH
Donau-City-Straße 1
1220 Wien
T +43/(0)1/258 26 01-0
F +43/(0)1/258 26 01-82845
info@zumtobel.at
www.zumtobel.at

Switzerland

Zumtobel Licht AG
Thurgauerstrasse 39
8050 Zürich
T +41/(0)44/305 35 35
F +41/(0)44/305 35 36
info@zumtobel.ch
www.zumtobel.ch

Headquarter

Zumtobel Lighting GmbH
Schweizer Straße 30
Postfach 72
6851 Dornbirn, AUSTRIA
T +43/(0)5572/390-0
F +43/(0)5572/22 826
info@zumtobel.info